



Pulse Emitter Water Meter

PULSE EMITTER WATER METERS

CTFI & CTCI & CTFIT & CTCIT & CTFIG & CTCIG

CATFI & CATCI & CWFA & CWCA & CWFI



A.T.A. pulse emitter water meter are the ideal complements to A.T.A. pumps for proportional dosing.

Pulse emitter water meters provide accurate reading values and fast responses for the most accurate measurement.



Pulse Emitter Water Meter

TURBINE PULSE EMITTER WATER METER

- Threaded pulse emitter water meter for cold and hot water, single (mod. 15 - 20 - 25 - 30 - 40) and multiple (mod. 50) jet counter with wet or dry dial
- Thread sizes range: from 1/2" to 2"
- Brass case and head (except for 50mm 2" model with cast iron case and head)
- Working temperature: cold water up to 30° C, hot water up to 90° C (mod. CTCI)
- 2m cable length (RG58), equipped with BNC connector
- Reed contact with 10⁹ closing operations
- Max voltage 250 VAC, 200 VDC
- Max current 1.0 A
- Max power 10 VA
- Available water meter without pulse emitter



CTFI 50

- CTCI:** hot water pulse emitter water meter
- CTFI:** cold water pulse emitter water meter
- CTFIT:** cold water pulse emitter water meter, PTFE internal and external coating
- CTCIT:** hot water pulse emitter water meter, PTFE internal and external coating
- CTFIG:** cold water pulse emitter water meter with pump "C" holder
- CTCIG:** hot water pulse emitter water meter with pump "C" holder
- CATCI:** hot water pulse emitter water meter, dry dial
- CATFI:** cold water pulse emitter water meter, dry dial

Pulses per liter table for water meters CTFI / CTCI / CTFIT CTCIT CTFIG / CTCIG	Water Meter Caliber					
	15	20	25	30	40	50
Pulses for 1 lt	35 - 70 140 1 - 2 - 4	22 - 44 88 1 - 2 - 4	12 - 24 48 1 - 2 - 4	12 - 24 48 1 - 2 - 4	4,5 - 9 18 1 - 2 - 4	1, 2, 4
Pulses for 10 lt	1, 2, 4	1, 2, 4	1, 2, 4	1, 2, 4	1, 2, 4	1, 2, 4
Pulses for 100 lt	1, 2, 4	1, 2, 4	1, 2, 4	1, 2, 4	1, 2, 4	1, 2, 4
Pulses for 1000 lt	1, 2, 4	1, 2, 4	1, 2, 4	1, 2, 4	1, 2, 4	1, 2, 4

Pulses per liter table for CATFI / CATCI series water meters	Water Meter Caliber					
	15	20	25	30	40	50
Pulses for 1 lt	1, 2, 4	1, 2, 4	1, 2, 4	1, 2, 4	1, 2, 4	1, 2, 4
Pulses for 10 lt	1, 2, 4	1, 2, 4	1, 2, 4	1, 2, 4	1, 2, 4	1, 2, 4
Pulses for 100 lt	1, 2, 4	1, 2, 4	1, 2, 4	1, 2, 4	1, 2, 4	1, 2, 4
Pulses for 1000 lt	1, 2, 4	1, 2, 4	1, 2, 4	1, 2, 4	1, 2, 4	1, 2, 4

Gauge	mm inch	15 1/2	20 3/4	25 1	30 1.1/4	40 1.1/2	50 2
Inertial breaking	l/h	10	15	20	20	25	50
Max temporary flow delivery	m ³ /h	3	5	7	10	20	30
Flow delivery with 10m of load loss	m ³ /h	3	5	7	10	20	30
Nominal flow rate	m ³ /h	1.5	2.5	3.5	5	10	15
First precision delivery ±5%	l/h	30	50	70	100	200	450
Second precision delivery ±2%	l/h	120	200	280	400	800	3000
Max operation pressure	bar	16	16	16	16	16	16
Minimum reading	l	0.1	0.1	0.1	0.1	0.1	0.5
Maximum reading	m ³	10 ⁵	10 ⁵	10 ⁵	10 ⁵	10 ⁵	10 ⁶
Turbine revs per liter	g/l	34.8	22.5	11.7	11.7	4.5	3.16

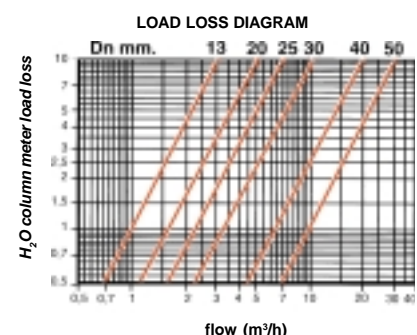
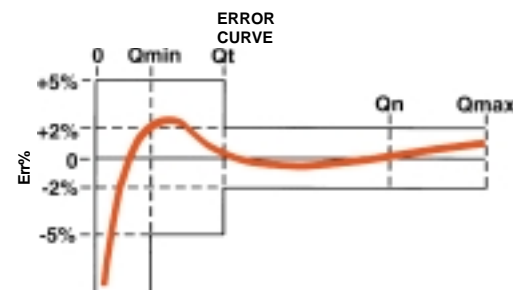

Pulse Emitter Water Meter

WOLTMANN PULSE EMITTER WATER METER

- Dry dial
- Threaded Woltmann (2") type for cold and hot water
- Flange sizes range: from 2" to 8"
- Woltmann water meter for horizontal and vertical assembly
- Epoxy coated cast iron housing (except for CWFI with brass housing)
- Working temperature: cold water up to 50° C
CWCA Mod. up to 90 °C and 16 bar
- Max voltage 250 Vac, 200 Vdc
- Max current 1.0 A
- Max power 10 VA
- Insulation voltage 4000 Vac
- Available water meter without pulse emitter



CWFA: Woltmann cold water pulse emitter water meter

CWCA: Woltmann hot water pulse emitter water meter

CWFI: Woltmann cold water pulse emitter water meter (threaded 2")

Pulses per liter table for CWFA / CWCA / CWFI series water meters	Water Meter Caliber					
	50 - 2"	65 - 2,5"	80 - 3"	100 - 4"	150 - 6"	200 - 8"
Pulses for 10 lt	1, 2, 4	1, 2, 4	1, 2, 4	n/a	n/a	n/a
Pulses for 100 lt	1, 2, 4	1, 2, 4	1, 2, 4	1, 2, 4	1, 2, 4	n/a
Pulses for 1000 lt	1, 2, 4	1, 2, 4	1, 2, 4	1, 2, 4	1, 2, 4	1, 2, 4
Pulses for 10000 lt	n/a	n/a	n/a	1, 2, 4	1, 2, 4	1, 2, 4

Gauge	mm inch	50 2	65 2,5	80 3	100 4	150 6	200 8
Inertial breaking	m ³ /h	0,4	0,4	0,4	0,6	1,8	2
Max temporary flow delivery Q _{max}	m ³ /h	30	50	80	120	300	500
Flow delivery with 1m of head loss	m ³ /h	20	55	90	140	410	610
Nominal flow rate Q _n	m ³ /h	15	25	40	60	150	250
First precision delivery (±2%) Q _t	m ³ /h	3	5,5	7	12	8	8,5
Transitional flow rate ±5% Q _{min}	m ³ /h	1,2	2	2,5	3,6	4,5	7
Max operation pressure	bar	16	16	16	16	16	16
Minimum reading	l	1	1	1	10	10	100
Maximum reading	m ³	10 ⁶	10 ⁶	10 ⁶	10 ⁷	10 ⁷	10 ⁸

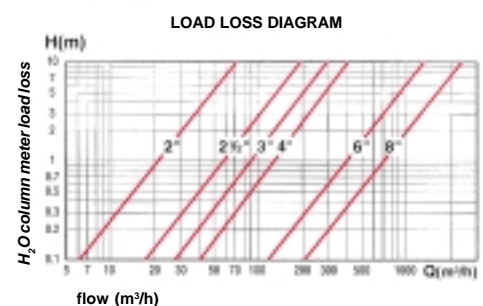
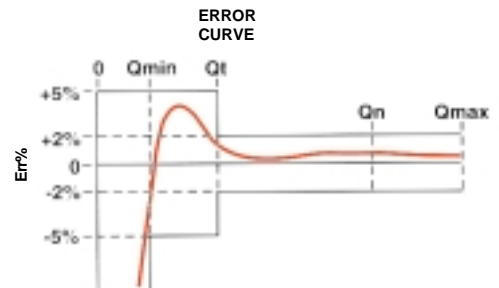

Dimensions

TURBINE PULSE EMITTER WATER METER

Gauge	mm	15	20	25	30	40	50
	inch	1/2	3/4	1	1.1/4	1.1/2	2
Length without hose fittings	A mm	110	130	160	160	200	300
Length with hose fittings	B mm	190	228	260	280	340	-
Width	C mm	80	80	100	100	110	108
Height	D mm	110	110	132	132	137	130,5
Height from hose	E mm	24	24	34	34	42	50,5
Weight with hose fitting	Kg	0,850	1,100	1,750	2,000	3,460	-
CEE approval number		B93 320 01	B93 320 02	B97 320 03	B97 320 04	B99 320 11	B02 320 12

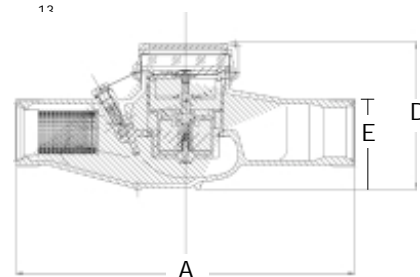
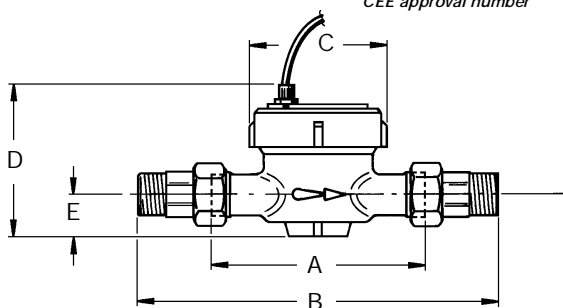

WOLTMANN PULSE EMITTER WATER METER

Gauge 50 - 65 mm

CWFI 50

Gauge 80 - 100 - 150 - 200 mm

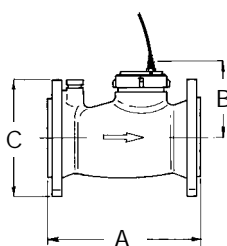

Gauge	mm	50	65	80	100	150	200	50
	inch	2	2.5	3	4	6	8	2
Total Length	A mm	200	220	230	280	300	350	200
Height	B mm	135	150	155	155	210	210	175
Diameter	C mm	165	185	200	225	283	340	-
Holes Circle	D mm	125	145	160	180	240	295	-
Holes numbers		4	4	8	8	8	12	-
Weight	Kg	9.5	10	16	20	39	52	5

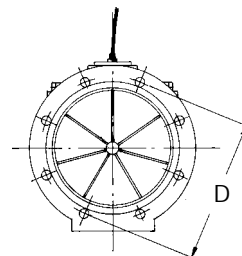
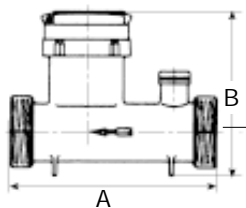
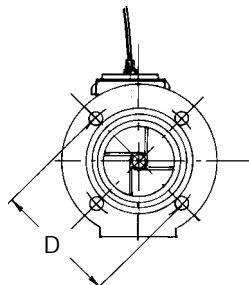
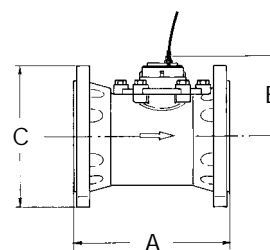

ATA S.r.l.

Sede legale - Via Luggiolo 32C 16035 Rapallo (GE)
 Ufficio e Laboratorio - Via Bosena 45 16035 Rapallo (GE)
 Piva 03588120109 Tel 39-0185-263015 Fax 39-0185-260114
 Http://www.ata srl.it Email: atasrl@ata srl.it

sistemi di dosaggio
 trattamento acque
 fertirrigazione
 automazione