

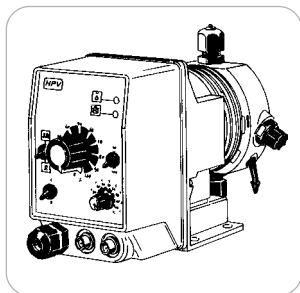

This operating instructions contains safety information that if ignored can endanger life or result in serious injury. They are indicated by this icon.



Use of this pump with radioactive chemicals is forbidden!



## OPERATING INSTRUCTIONS MANUAL FOR "H" SERIES DOSING PUMP



Keep the pump protected from sun and water.  
Avoid water splashes.

Please read it carefully!



English language

R1-03-04

## « CE » referring norms



“H” series dosing pumps comply with the following European regulations:

EN60335-1 : 1995, EN55014, EN50081-1/2, EN50082-1/2, EN6055-2, EN60555,3

Based on directive CEE 73/23 c 93/68 (DBT Low voltage directive) and directive 89/336/CEE (EMC Electromagnetic Compatibility)



All metering pumps supplied with 115 VAC are available with certification CSA, except for 20 01, 18 02 and 07 06 models.



## GENERAL SAFETY GUIDELINES

### **Danger!**

In emergencies the pump should be switched off immediately! Disconnect the power cable from the power supply!

When using pumps with aggressive chemicals observe the regulations concerning the transport and storage of aggressive fluids!

When installing outside European Community, always observe national regulations!

Manufacturer is not liable for any unauthorized use or misuse of this product that can cause injury or damage to persons or materials!

### **Caution!**

Pumps must be accessible at all times for both operating and servicing. Access must not be obstructed in any way!

Feeder should be interlocked with a no-flow protection device to automatically shut-off the pump when there is no flow!

Pumps and accessories must be serviced and repaired by qualified and authorized personnel only!

Always discharge the liquid end before servicing the pump!

Empty and rinse the liquid end before work on a pump which has been used with hazardous or unknown chemicals!

Always read chemical safety datasheet!

Always wear protective clothing when handling hazardous or unknown chemicals!

# Index

GENERAL INFORMATION .....	4
INSTALLATION .....	4
METERING .....	5
LEVEL PROBE AND FOOT FILTER INSTALLATION .....	5
SINGLE STROKE INJECTION ADJUSTMENT .....	6
ELECTRICAL PROTECTION .....	8
LEVEL ALARM .....	8
PUMP TYPES .....	9
MAINTENANCE .....	11
REPAIR .....	11
QUICK TROUBLESHOOTING GUIDE .....	12
O-RINGS .....	12
CONSTRUCTION MATERIALS .....	13
PROVIDED ACCESSORIES .....	13
PRINTED CIRCUIT BOARD CONNECTIONS .....	15
CAPACITY CURVES .....	17
PUMP INSTALLATION DRAWINGS .....	17
“H” SERIES PUMP EXPLODED VIEW .....	23
“H” SERIES DIMENSIONS .....	24
SELF-VENTING PUMP HEAD .....	25



**Technical features and drawings are subject to changes and modifications without any advice.**

## GENERAL INFORMATION

The “H” series magnetic diaphragm dosing pumps are the ideal solution for small and medium dosing of liquid products. They are constituted of the following main parts:

*Box*  
*Electronic Circuitry*  
*Solenoid*  
*Diaphragm*  
*Pump Head*

The pump working mode is intermittent: a magnetic field is created each time a pulse reaches the magnet. The magnetic field pushes the piston. A diaphragm (fixed on the piston head) compresses the liquid into the pump head. The liquid gets out through the delivery valves while the suction valves close. When the pulse ends, a spring takes back the piston and the diaphragm. The vacuum created by the diaphragm movement takes the liquid inside the pump head from the suction valve, while the delivery valve is closed. The pump capacity is proportional to the number of strokes and to the pump head internal volume (Single Stroke Injection Quantity).

### *Box*

The “H” series dosing pumps are assembled in IP65 (PP) plastic material boxes. Installation is wall mounting by means of four screws.

### *Electronic Circuit*

The electronic circuit is made of proved quality components. It provides the necessary electrical pulses to the magnet.

### *Solenoid*

The solenoid driven by the electronic circuit, gives the necessary pushes to the piston and the diaphragm. The piston displacement range is from 0.8mm to 1.6mm.

### *Diaphragm*

PTFE diaphragms used in the “H” series pumps assure good chemical compatibility and mechanical resistance.

### *Pump Head*

The pump head works as a dosing chamber, the suction valve, delivery and manual outgassing valves are inside it. The purpose of the manual outgassing valve is to help the priming of pump during installation.

## INSTALLATION

The pump is supplied with all the materials needed for the installation. To setup the “H” series pump, first mount it on a bracket or any other horizontal surface in a well aerated and easily accessible environment. The distance between the pump head and the suction filter should not be more than 1.5m. Connect the suction pipe (the transparent one) to the suction fittings (bottom pump head valve). Be sure that the o-ring in the suction valve is in place. Use only the hands to tight the fitting nut. Place the suction filter on the bottom of the product tank. The suction pipe should be as short as possible, in vertical position and without any bends to avoid air bubbles. Install the injection valve. Connect one end of the delivery pipe (opaque one) to the delivery fitting on top of the pump head and the other end to the injection valve previously installed.



**To avoid delivery pipe breaking be sure that it doesn't touch any other object.**

Always install the injection valve at the end of the rigid delivery hose. The injection valve should never be installed lower than the product tank to avoid that an injection valve breaking lets the product flow freely into the system. If the only way to install the injection valve is to keep it lower than the tank then it is recommended to use an anti-siphon valve on the delivery side. This valve prevents vacuum on the pump. Check regularly the delivery valve status and immediately change if inoperable or broken. Do not install tanks with chemical beneath the pump: vapours may damage the pump.



**FREE END OF SUCTION HOSE SHOULD BE INSERTED JUST ABOVE THE BASE OF NOOZLE!**

**USE ONLY HOSES COMPATIBLES WITH PRODUCT TO DOSE. PLEASE REFERS TO OUR “CHEMICAL COMPATIBILITY TABLE” !**

## **PRIMING**

To prime the pump without touching chemicals please do as follow:

- connect all hoses into proper places (delivery hose, suction hose, outgassing hose).
- open outgassing valve and turn on the pump.
- set pump's single injection at 100% and pulses at 50%.

All air inside the pump head will exit through the outgassing outlet. When product will leak from it, close immediately the outgassing valve. If dosing product is particularly dense, to facilitate the priming, insert on vent pipe a syringe of 20 cc and suck inside.

## **METERING**

The “H” series pump technical features are printed on a label located at the left side of pump box. They include: power supply, working counterpressure (Kpa/bar) and pump capacity in liter per hour (l/h). All these dosing information are calculated by dosing water at 20 °C temperature, at the maximum counterpressure reported on the label, using the injection valve and the % knob set to maximum. Dosing accuracy is  $\pm 2\%$  l/h at constant maximum counterpressure and 1 cps flow (**max viscosity: 60 cps**).



**Caution: injection capacity is a constant value but a variation in counterpressure or product's viscosity may cause some changes. For further details see “Delivery curves” paragraph.**

## **LEVEL PROBE AND FOOT FILTER INSTALLATION**

Level probe must be assembled using the foot valve included into pump's kit. Foot valve is designed to be installed in contact with tank base. It is not necessary a space to avoid sediment accumulation. Connect the BNC to dosing pump using “LEVEL” input.

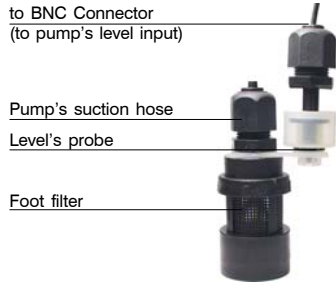
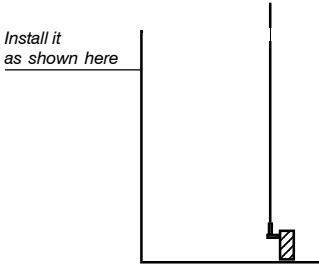

## SINGLE STROKE INJECTION ADJUSTMENT

The "H" series pumps have a double flow setting that can be operated at same time: the number of strokes per minute and the single stroke capacity. This feature results in a more accuracy of the metering. The single stroke capacity adjustment is a mechanical control on the piston that pushes the diaphragm and it is operated through the central panel knob. This knob is locked to avoid undesired metering by accidental movement. To unlock it push the knob and rotate it on the needed value.



**Warning: to avoid mechanical damages the piston displacement adjustment must be done when the pump is working.**

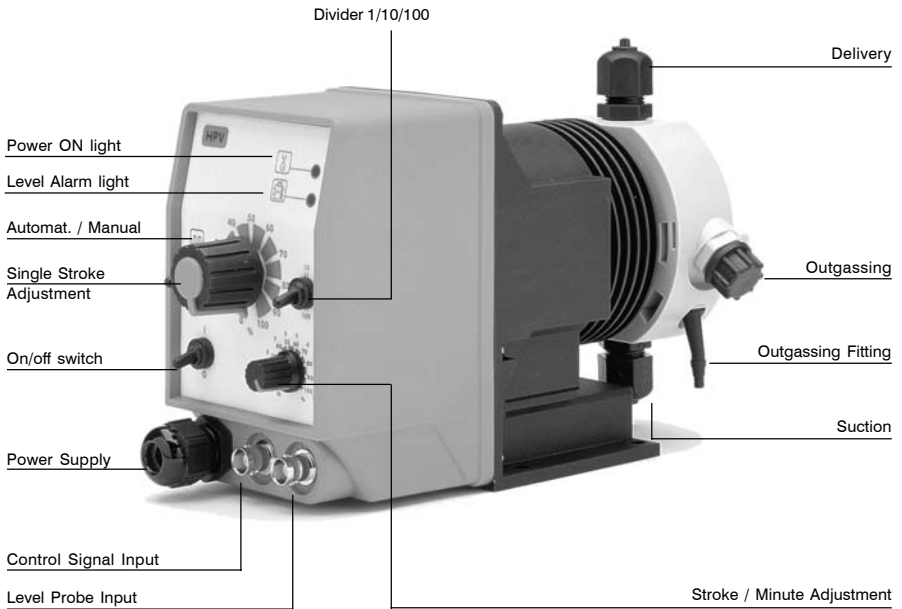

## ELECTRICAL CONNECTIONS

Pump has to be connected to power supply using the standard "SCHUKO" plug supplied or the special power supply cable.

**Before starting any electrical connection perform the following operations:**

- ensure a correct ground installation!
- if there is a bad ground, install a differential switch with high sensibility (0,03 A) as additional protection from electric shocks!
- check that pump voltage corresponds to supply voltage!
- make ground connection before any other connection!

**REPAIR MUST BE PERFORMED BY AUTHORIZED PERSONNEL ONLY.**

Electrical features:

Power supply range for 230 VAC models	198 ÷ 242 VAC
Power supply range for 115 VAC models	99 ÷ 121 VAC
Frequency	50 ÷ 60 Hz

<i>Pump Model</i>	<i>Consumption (115 VAC)</i>	<i>Consumption (230 VAC)</i>
<b>Hxx 2001</b>	24 W	19 W
<b>Hxx 1802</b>	24 W	19 W
<b>Hxx 1801</b>	24 W	19 W
<b>Hxx 1402</b>	24 W	19 W
<b>Hxx 1004</b>	24 W	19 W
<b>Hxx 0706</b>	24 W	19 W
<b>Hxx 0408</b>	24 W	19 W
<b>Hxx 0216</b>	24 W	19 W

*Pump power "on" is confirmed with a green led on the frontal panel that turns off each stroke.*

**Do not connect the pump in parallel to an inductance load, e.g. motors, to prevent electronic circuitry damages. Always use a connector to cut off spikes due to other devices switching.**

**Dosing pump in parallel connection with inductive loads**

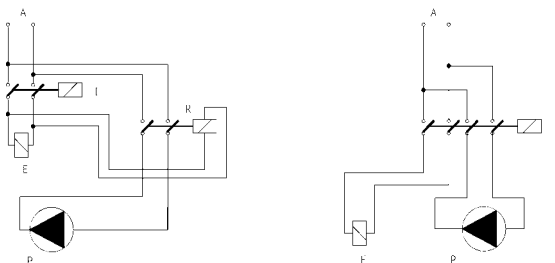

*P - Metering Pump*  
*R - Relay*  
*I - Connector or Multi-Pole Safety Device*  
*E - Inductance Load*  
*A - Power Supply*

## ELECTRICAL PROTECTION

Internal circuitry is protected against noises using the EMC system and with a fuse located under the front cover of pump. To replace the fuse (**trained personnel only**) do as follow:

- **unplug power supply**
- **fully rotate counter clockwise piston displacement knob**
- **remove the 6 screws on the front cover of the pump**
- **remove pulling horizontally the frontal cover**
- **replace fuse, use only approved fuses reported in table below**
- **put back cover in place, take care of seal and piston displacement knob position**

Each pump type fuse (**5x20**) **T(delayed)** can be found in table below:

<i>Model Pump "H"</i>	<i>Fuse (Power supply 230 VAC)</i>	<i>Fuse (Power supply 115 VAC)</i>
<b>Hxx 2001</b>	800mA T	500mA T
<b>Hxx 1802</b>	800mA T	500mA T
<b>Hxx 1801</b>	800mA T	500mA T
<b>Hxx 1402</b>	800mA T	500mA T
<b>Hxx 1004</b>	800mA T	500mA T
<b>Hxx 0706</b>	800mA T	500mA T
<b>Hxx 0408</b>	800mA T	500mA T
<b>Hxx 0216</b>	800mA T	500mA T

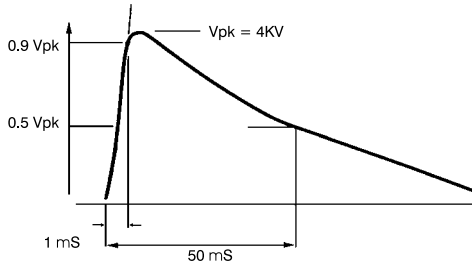

fig. 1

"H" pump is equipped with an overvoltage protection (working voltages: 275 V, 150V, 39V) and a voltage peak protection up to 4 KV, 50  $\mu$ sec against pulses as shown in fig. 1.

## LEVEL ALARM

CL, IS, IC, PV and TE type pump are provided with a liquid level alarm to indicate if product tank is empty. The level probe is connected to the right BNC plug on pump's bottom panel. The level probe is made of a N.O. reed contact (10VA, 1A max, 230Vac max) closed by a floating magnet housed in a (PP) plastic box. When the product level goes below the minimum the magnet closes the reed contact. The pump stops and the red LED on pump's front panel indicates the alarm status.



## PUMP TYPES

“H” series pump capacity can be reduced 10 or 100 times operating the 1/10/100 switch in the frontal panel, the % marked knob will act on this set capacity.



### - HCO -

*Constant* dosing pump with stroke speed adjustment between 0 and 100% of indicated capacity (see label on pump type). The % marked knob sets the pump capacity, changing linearly the magnet stroke number per minute. It is strongly suggested to not operate the pump in the range from 0 to 10%, since there is not a linear correlation with the pump stroke speed in that range. This pump is specially designed for constant dosing rates. HCO pump can be ON/OFF driven by a LPH or a LCD instrument. To set 2 l/h against 10 bar on a HCO 1004 the % marked knob should be set to 50%.

### - HCL -

*Constant dosing pump with level alarm*, provided with a floating magnetic sensor probe. A red led indicates that the pump stops dosing because the product tank is empty. This pump has the same features and adjustments of the CO type pump.



### - HIC -

*Proportional/constant* pump driven by current signal. Setting the switch on the *constant*  position, the pump has the same features and adjustments of the CL pump. Setting the switch on the *proportional*  position, the pump capacity is set proportionally to a given analog current signal; a given linear change of the signal will be followed by a linear change of capacity.

The current signal accepted range is 0÷20 mA (it can be changed upon demand). The maximum pump capacity requested by the maximum input signal is set by the % marked knob. The IC pump can be driven by any electronic device (such as pH-meter, RH-meter, etc) that gives an analog current signal output. This signal must be applied to the bipolar cable provided with the pump, already internal connected, being care to connections:



- red wire: *positive (+)*
- black wire: *negative (-)*

### - HIS -

*Proportional/constant* pump driven by a digital signal. Setting the switch on the *constant*  position, the pump has the same features and adjustments of the CL pump. Setting the switch on the *proportional*  position, to each external voltage free pulse correspond a magnet stroke. When proportional position is set, the % marked knob does NOT affect the pump capacity. The IS proportional dosing pump can be driven by any external device (PCs, PLCs, etc.) that produce a digital signal. The digital signal (N.O. contact) must be applied to the cable provided with the pump, already internal connected. If it is requested a 0÷5; 0÷12 Vdc input signal option, be care to connections:

- red wire: *positive (+)*
- black wire: *negative (-)*

### - HPV -

*Proportional/constant* pump driven by a water meter digital signal. Setting the switch on the *constant*  position, the pump has the same features and adjustments of the CL pump. It is furthermore possible to divide the maximum magnet strokes per minute by 1, 10 and 100 using the switch on the front panel. Setting the switch on the *proportional*  position, to each external pulse

correspond one pump stroke. This pump can be driven by a CTFI or CWFI series water meters. This pump can also be driven by a digital signal coming from a voltage free contact. Driving signal is applied on the BNC plug on the left bottom of the front cover. Dividing factor (N) value is obtained multiplying the value indicated on the adjustment knob by the multiplying switch (x1, x10, x100) value.

*Capacity definition for "HPV" pump*

Given the water m<sup>3</sup> to be treated and the product amount to dose in p.p.m., the minimum pump capacity to be used can be obtained with the following formula:

$$\frac{\text{ppm} \times K \times m^3}{1000} = \text{l/h}$$

- l/h* - minimum pump capacity required
- ppm* - product amount to dose in p.p.m. (gr/m<sup>3</sup>)
- k* - dosed product dilution factor (pure chemical k=1)
- m<sup>3</sup>* - maximum capacity of the system to be treated in m<sup>3</sup> /h.

Dividing factor (N) to be set on the adjustment knob is given by the following formula:

$$\left( \frac{\text{imp/l} \times \text{cc}}{\text{ppm} \times K} \right) \times 1000 = N$$

- N* - is the number the external pulses are divided by to be set on the adjustment knob
- imp/l* - pulse per liter given by the water meter
- cc* - pump's single stroke dosing quantity (in cc). Refer to following table
- k* - dosed product dilution factor (pure chemical k=1)
- ppm\** - product amount to dose in p.p.m. (gr/m<sup>3</sup>)
- \* 10.000 ppm equals to 1%

<b>Pump model</b>	<b>cc max</b>	<b>Piston displacement</b>
H PV 2001	0,14	100%
H PV 1802	0,23	100%
H PV 1801	0,12	100%
H PV 1402	0,23	100%
H PV 1004	0,45	100%
H PV 0706	0,66	100%
H PV 0408	0,89	100%
H PV 0216	1,8	100%



If the dividing factor (N), obtained with the above formula, is <1, a pump with higher single stroke dosing quantity is required or the water meter needs to be changed with one that gives higher number of pulses per liter. In some application this issue can be solved reducing the dosed product dilution factor. If dosed amount is higher than the needed one, the set dividing factor (N) can be increased.

**- HPVM -**

*Proportional/constant* pump driven by a water meter digital signal. Setting the switch on the *constant* position , the pump has the same features and adjustments of the CL pump. It is

furthermore possible to divide the maximum magnet strokes per minute by 1 ( $\div 1$ ), 10 ( $\div 10$ ) and 100 ( $\div 100$ ) using the selector on the front panel. The electronic capacity adjustment sets the injection per minute. Setting the switch on the *proportional* position  and the selector on “multiplier” (X1), the pump multiplies the external pulses between 1 and 10. Setting the selector on “divider” ( $\div 1$  or  $\div 10$ ) the pump divides the external pulses between 1 and 100. This pump can be driven by a CTFI or CWFI series water meters. This pump can also be driven by a digital signal coming from a voltage free contact. Driving signal is applied on the BNC plug on the left of the bottom pump cover.

- HTE -

*Timered/constant* dosing pump. Setting the switch on the *constant*  position, the pump has the same features and adjustments of the CL pump. Setting the switch on *timered*  position, the pump starts working when an external pulse is provided. Working active time for each external pulse is set on the adjustment knob in the range between 0 and 60 seconds (different time are available upon demand). The capacity can also be changed adjusting the stroke per minute, operating the % marked knob, at the same time. The double parameter adjustment (strokes and time) allows the use of this pump in high capacity systems, where the pulses are not enough to drive a PV type pump. TE pump is provided with a coaxial cable (RG58) with BNC plug to connect the command signal. Use following formula to evaluate the  knob adjustment:

$$\frac{3600}{\text{imp/h}} = \text{sec.}$$

*imp/h* - water meter output pulse per hour  
*sec* - time in seconds to be set on time knob

## MAINTENANCE

Every month (when in normal use) pump and accessories should be checked for proper operation. For a correct maintenance, please perform following tasks:

- check electrical connections
- check liquid end screws
- check discharge line connections
- check discharge and suction valve connections
- check the entire liquid end for leakage
- check feed rate: run the pump for a short period in priming mode

## REPAIR



**All repair measures must be performed by authorized and qualified personnel. If pump needs to be repaired in manufacturer’s factory send it only if it has been cleaned and after the liquid end has been rinsed!**

If, despite pump’s emptying and cleaning, there are still possible safety hazards the information must be declared on return’s form!



**If pump needs a replacement use only ORIGINAL spare parts!**

Replacing discharge valve:

- remove discharge line
- unscrew discharge valve from the liquid end
- remove oring from the liquid end
- screw in the new discharge valve with oring up to the stop
- refit discharge line

## QUICK TROUBLESHOOTING GUIDE

*If...pump does not work and the green led is off:*

- check and verify power supply;
- verify provided power supply is the same reported in the pump tag;
- check fuse integrity and eventually replace it;
- replace electronic PCB.

*If...pump does not work and the red led is on:*

- check and ensure product tank is not empty;
- check level probe floater, replace it if blocked down;
- remove crystallized product that can block the level probe floater.

*If...pump does not work and the green led flashes*

- check and verify foot filter is not obstructed with impurities and chemical crystals;
- some air can be in the pump head. Remove it as described in the PRIMING section;
- check and ensure suction and delivery valves are not obstructed with product crystals;
- check and verify valves o-ring are not swell or damaged, it's a clear evidence of chemical incompatibility with used products (see "o-rings" section).

*If...pump blows fuse after working a while:*

- check and ensure supplied power is the same reported in pump tag;
  - check electronic circuitry connecting it to a lamp(of the right voltages) instead of the magnet.
- All connections are "quick lock" made so: it's a quick test to perform, if the lamp does not light intermittently the electronic PCB needs to be replaced;
- check and ensure magnet impedance is ( $\pm 5\%$ ) the tag one. If not, replace it.

## O-RINGS

The valve sealings are provided in 5 different types to satisfy different chemical compatibility issues. The elastomer that will best fit the requested needing can be found on the Manufacturer compatibility table. Get in touch with customer support if needed. The elastomer used for the o-rings equipping the "H" pumps are characterized by different suction/delivery valve colours.

<i>Elastomer</i>	<i>ISO Code</i>	<i>Manufacturer Code</i>	<i>Valve Colour</i>
Fluorocarbon	FPM	FP	black
Ethylenepropylene	EPDM	EP	grey
Polytetrafluoroethylene	PTFE	PTFE	blue
Nitrile	NBR	WAX	green
Silicone	MVQ	SI	yellow

## TECHNICAL FEATURES

<i>Pump strokes per minute:</i>	0 ÷ 150 ; 0 ÷ 120
<i>Max suction pipe length:</i>	1,5 meters
<i>Environment temperature:</i>	0 ÷ 45°C (32 ÷ 113°F)
<i>Chemical Temperature:</i>	0 ÷ 50°C (32 ÷ 122°F)
<i>Installation Class:</i>	II
<i>Pollution Level:</i>	2
<i>Audible Noise:</i>	74dbA
<i>Packaging and Transporting Temperature:</i>	-10 ÷ +50°C

## CONSTRUCTION MATERIALS

<i>Case:</i>	PP
<i>Pump Head:</i>	PP/PVDF
<i>Diaphragm:</i>	PTFE
<i>Valve Balls:</i>	Ceramic (upon demand Glass, PTFE, SS)
<i>Suction pipe:</i>	PVC/PE
<i>Delivery pipe:</i>	PE
<i>Valve body:</i>	PP/PVDF
<i>O-ring:</i>	as requested (FP, EP, WAX, SI, PTFE)
<i>Injection connector:</i>	PP/PVDF (glass ball, HASTELLOY C276 spring)
<i>Level Probe:</i>	PP/PVDF
<i>Level Probe cable:</i>	PE
<i>Foot Filter:</i>	PP/PVDF

**PVDF / PTFE furniture can be optionally provided**

## PROVIDED ACCESSORIES

<b>n.4</b>	Dibbles ø6
<b>n.4</b>	Screws 4,5 x 40
<b>n.1</b>	Fuse 5 X 20 delaied
<b>n.1</b>	Foot filter/valve assy
<b>n.1</b>	Injection valve
<b>n.1</b>	Level probe (not included in model CO)
<b>mt 2</b>	Delivery hose in white opaque polyethylene
<b>mt 2</b>	PVC or PE suction hose
<b>mt 2</b>	Transparent PVC outgassing hose
<b>n.1</b>	Instruction manual

Flow	Max Capacity l/h	Max Pressure bar	Capacity l/h	Pressure bar	ml stroke	Strokes/min	Hoses mm	Watt W	Shipping weight Kg
20 01	1	20	1,5	10	0,14	120	4 X 8	19 W	4,1
18 02	2	18	3	9	0,23	150	4 X 8	19 W	4,1
18 01	1	18	1,7	9	0,12	120	4 X 8	19 W	4,1
14 02	2	14	3,8	7	0,23	150	4 X 8	19 W	4,1
10 04	4	10	7	5	0,45	150	4 X 6	19 W	4,1
07 06	6	7	7	3,5	0,66	150	4 X 6	19 W	4,1
04 08	8	4	10	2	0,89	150	4 X 6	19 W	4,1
02 16	16	2	17	1	1,8	150	6 X 8	19 W	4,1



# Printed Circuit Board Connections

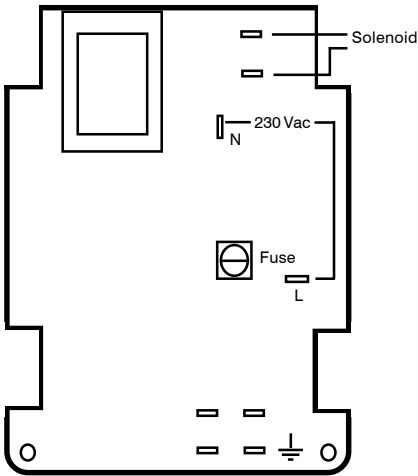

**Mod. H-CO**

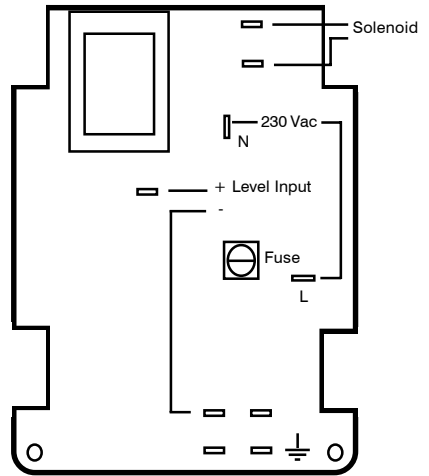

**Mod. H-CL**

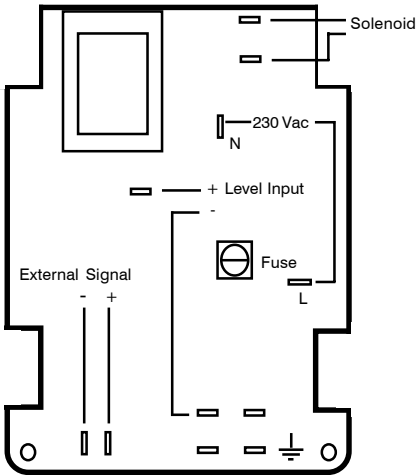

**Mod. H-IC/IS**

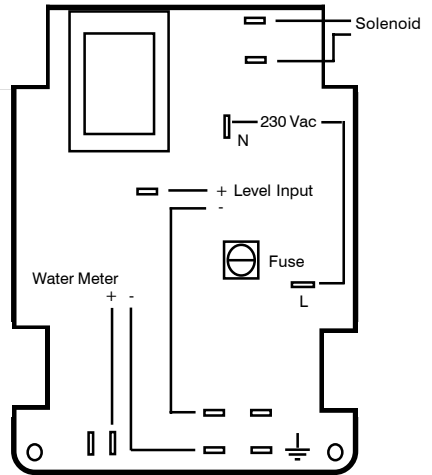

**Mod. H-PV/PVM/TE**

# Capacity Curves

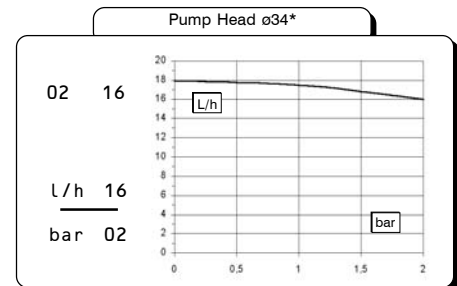
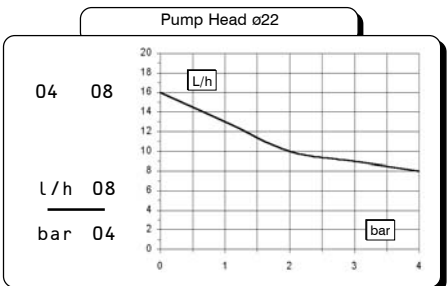
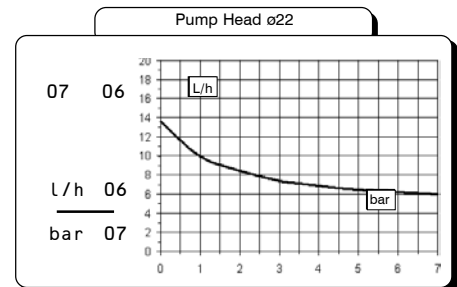
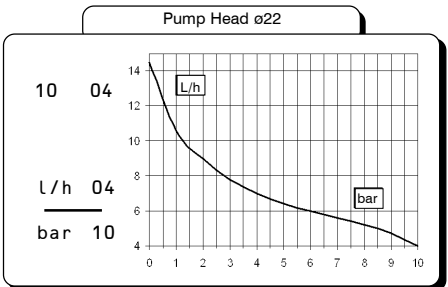
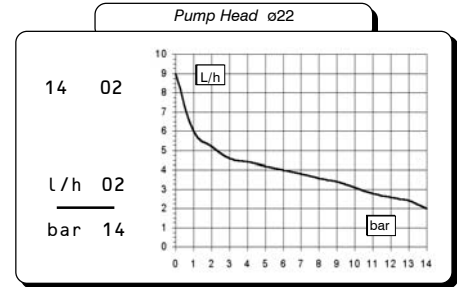
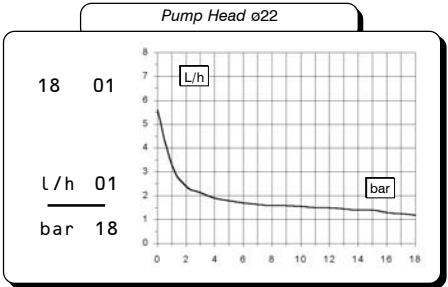
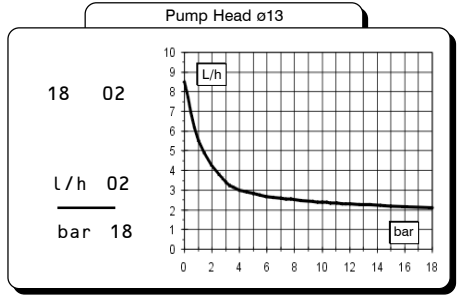
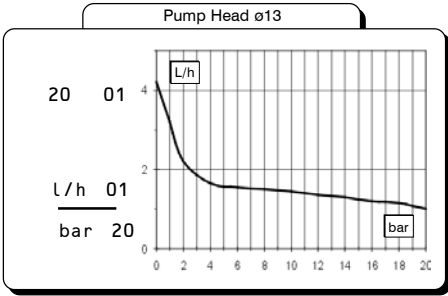

\*Available without venting valve

Flow rate indicated is for H<sub>2</sub>O at 20°C at the rated pressure. Dosing accuracy ± 2% at constant pressure ± 0,5 bar.



# "HCL" Pump Installation Drawing

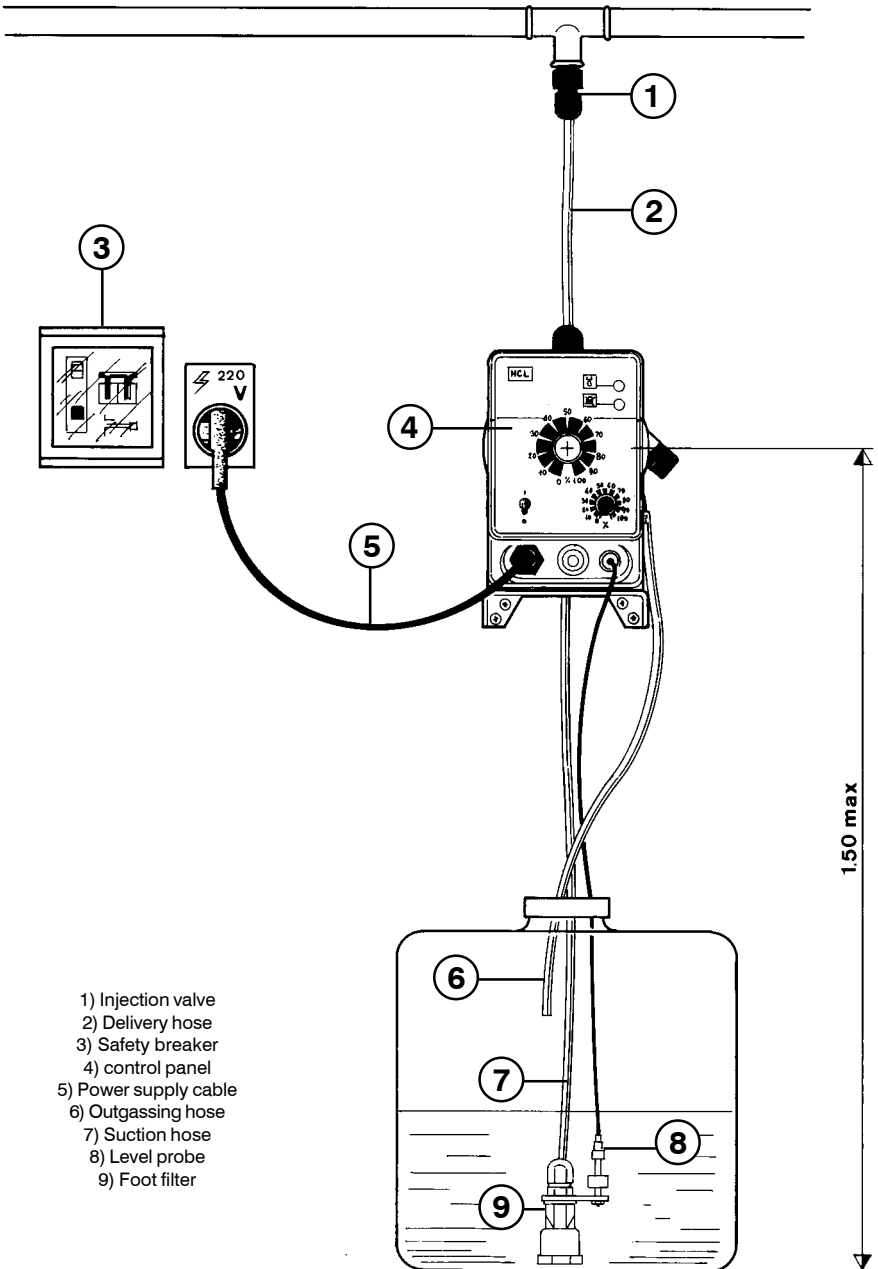

# "HCO" Pump Installation Drawing

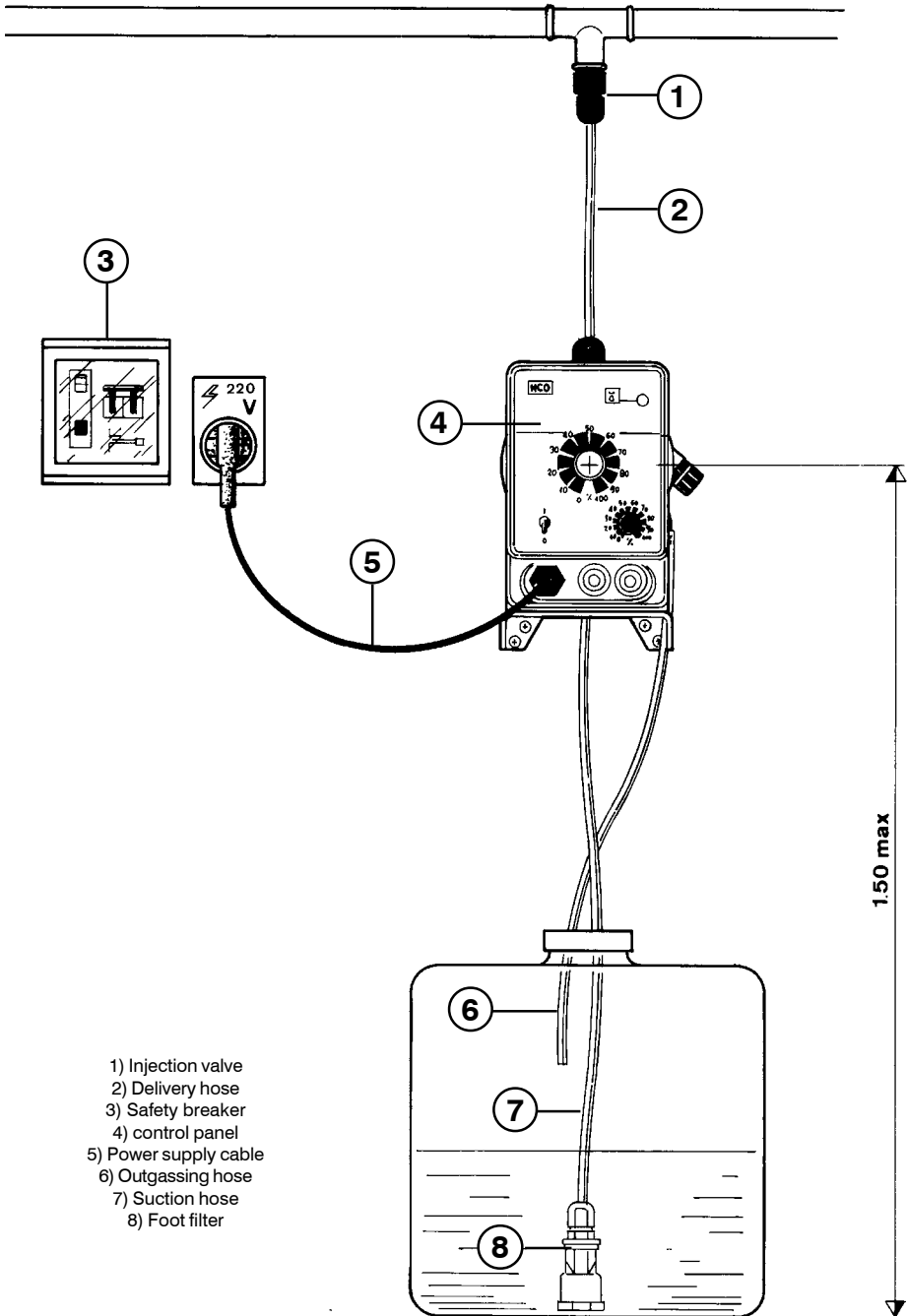

# "HIC" Pump Installation Drawing

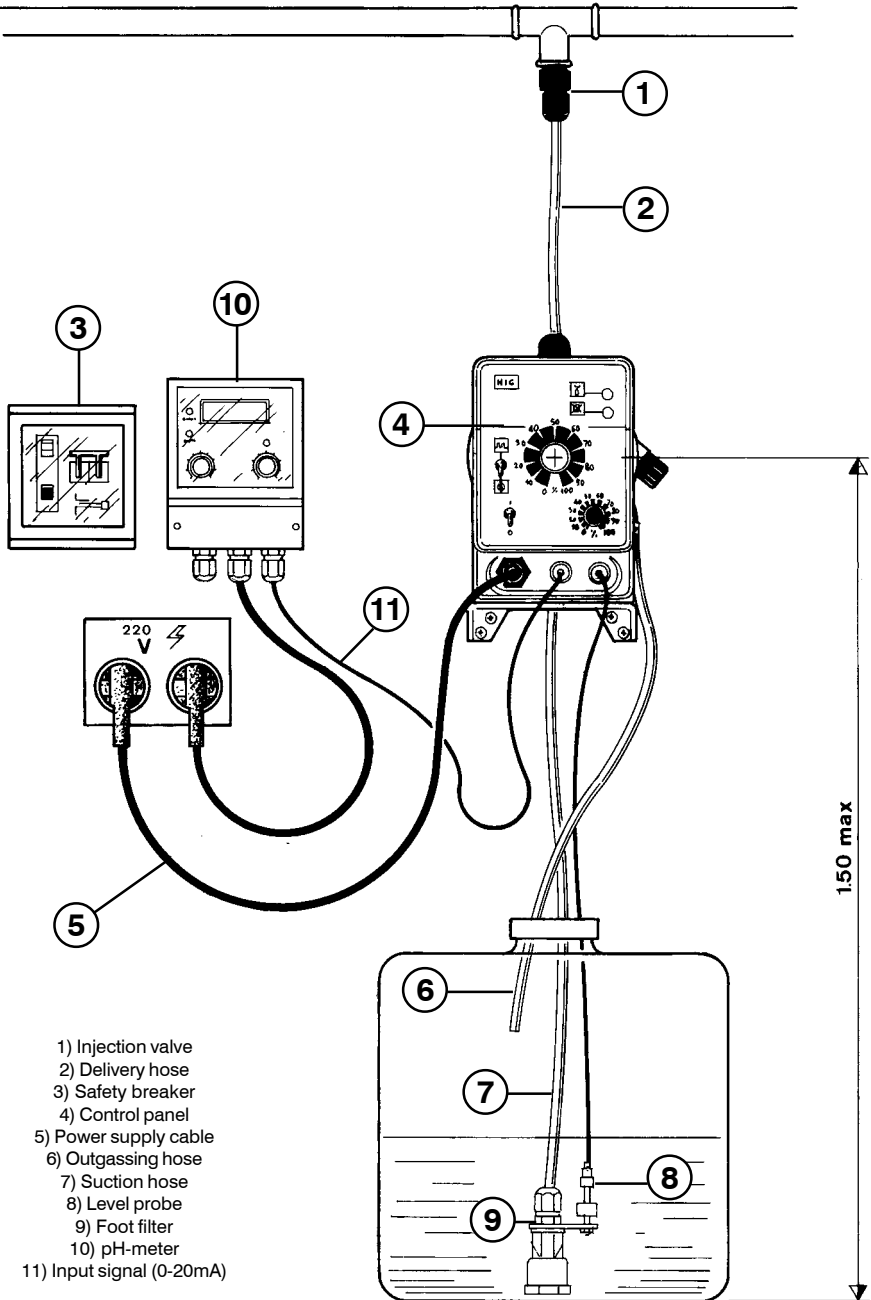

# "HTE" Pump Installation Drawing

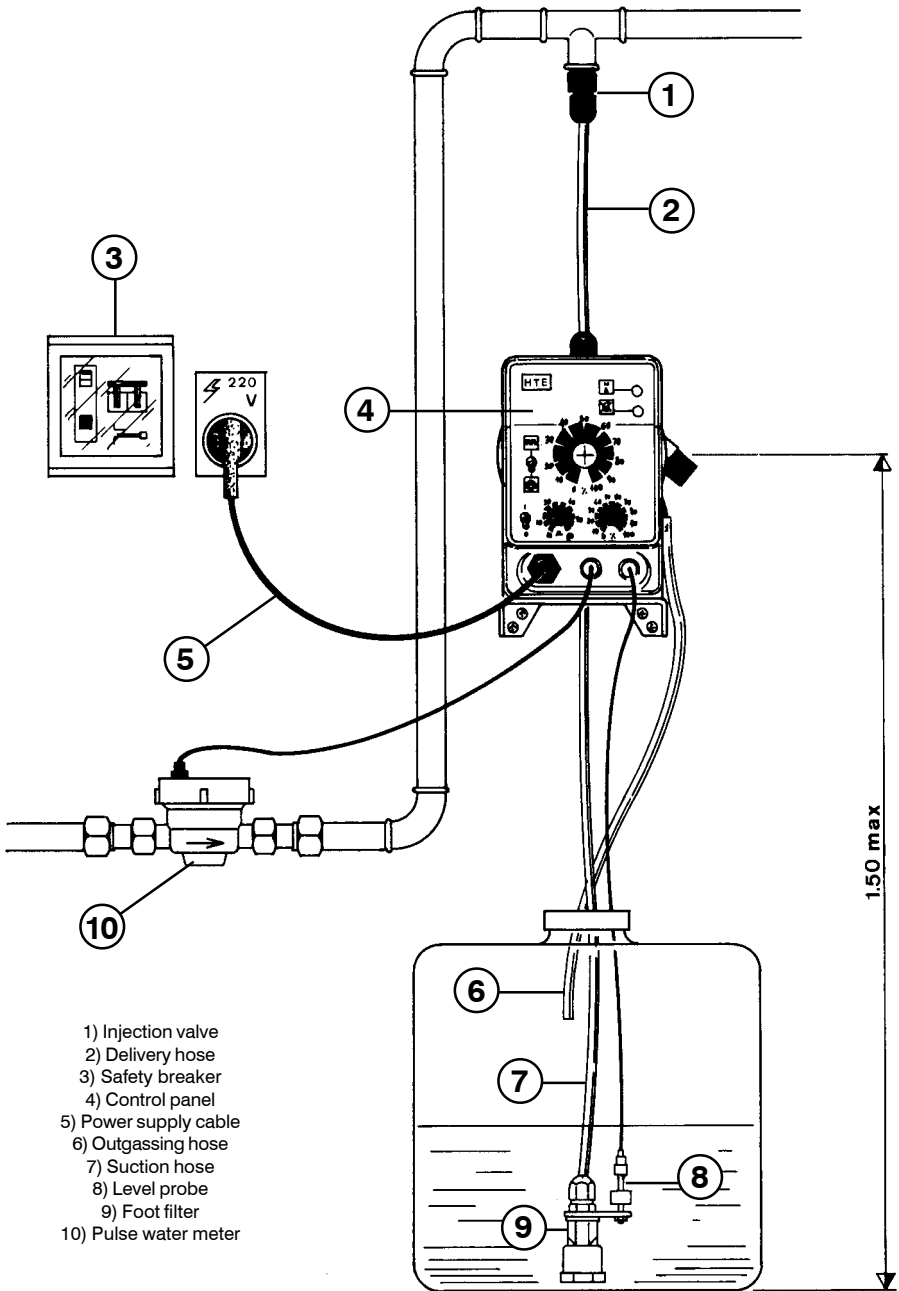

# "HPV" Pump Installation Drawing

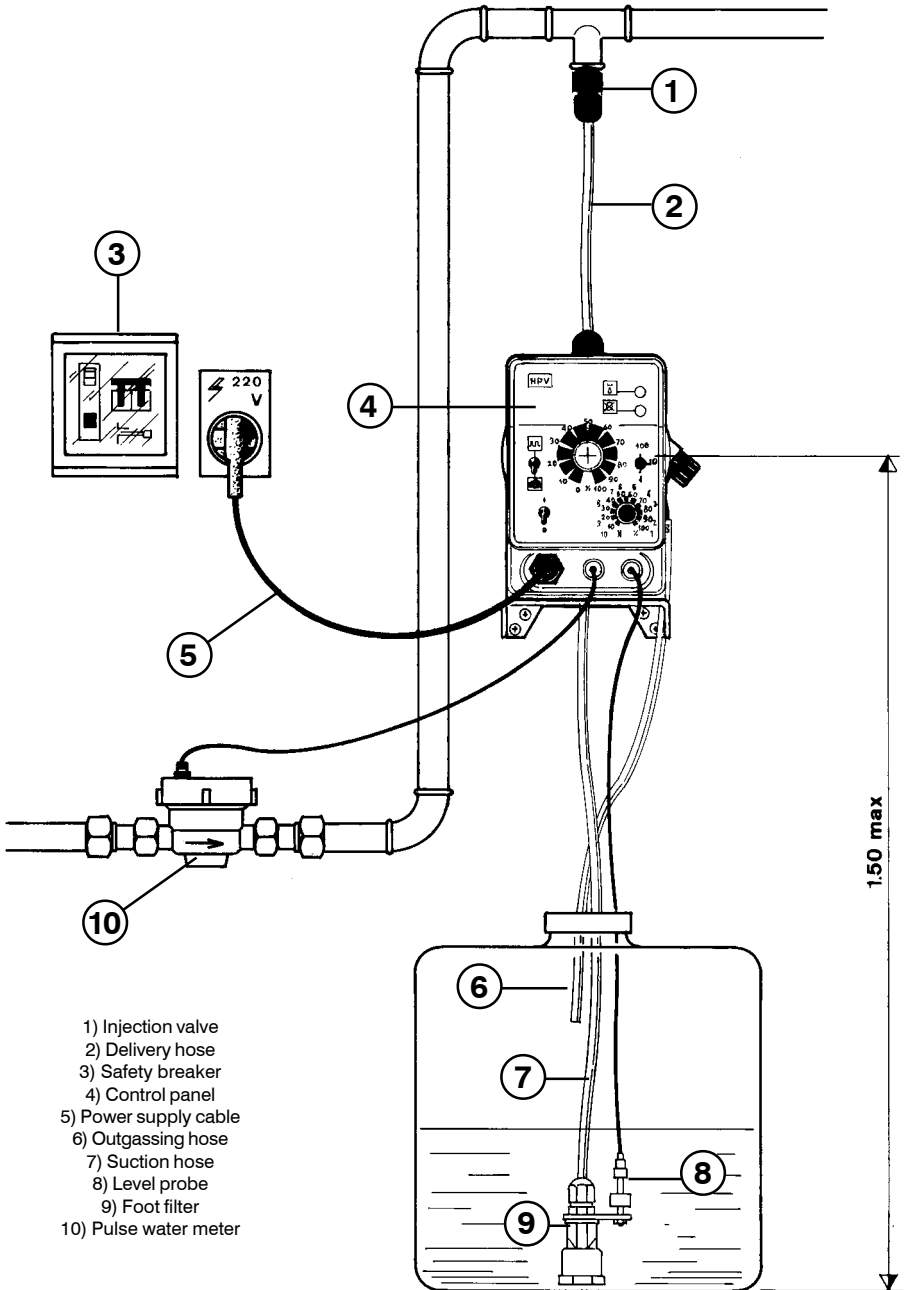

- 1) Injection valve
- 2) Delivery hose
- 3) Safety breaker
- 4) Control panel
- 5) Power supply cable
- 6) Outgassing hose
- 7) Suction hose
- 8) Level probe
- 9) Foot filter
- 10) Pulse water meter

# "HIS" Pump Installation Drawing

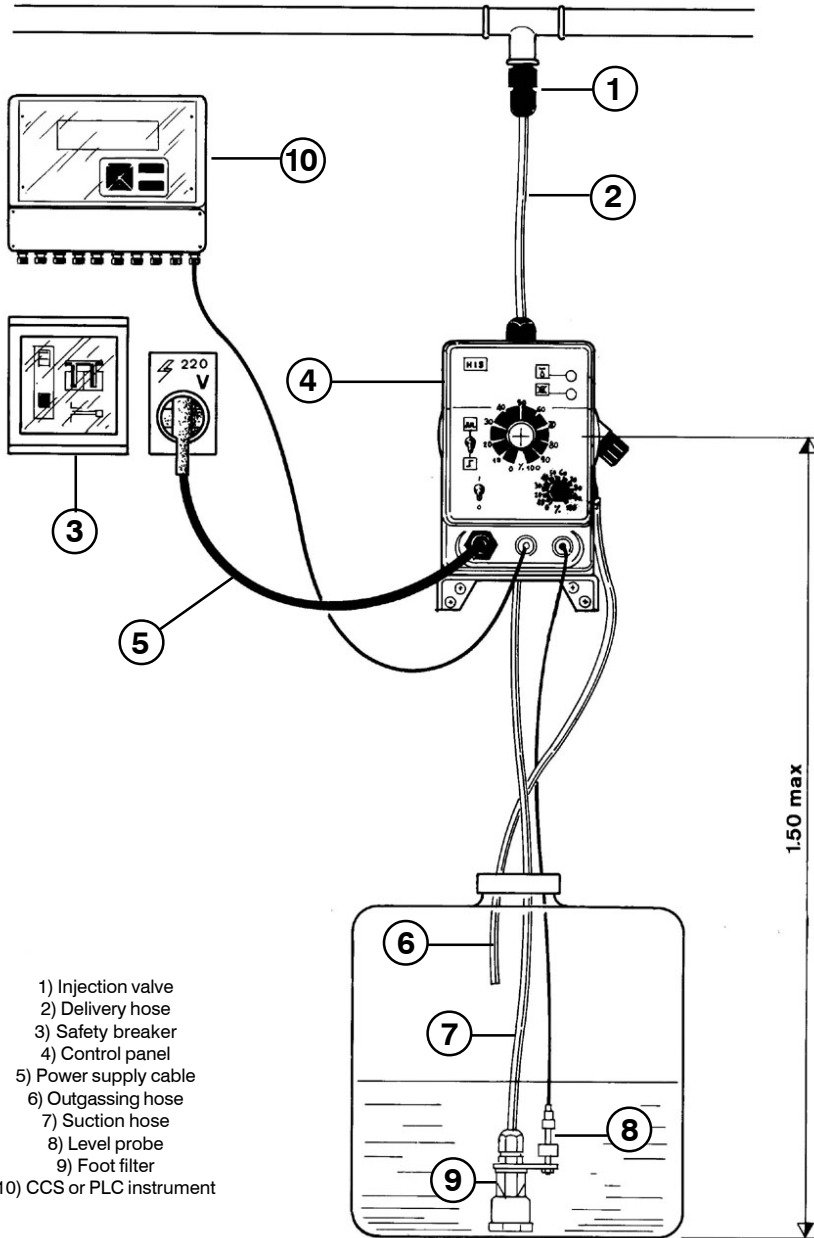

**"H" series pump exploded view**

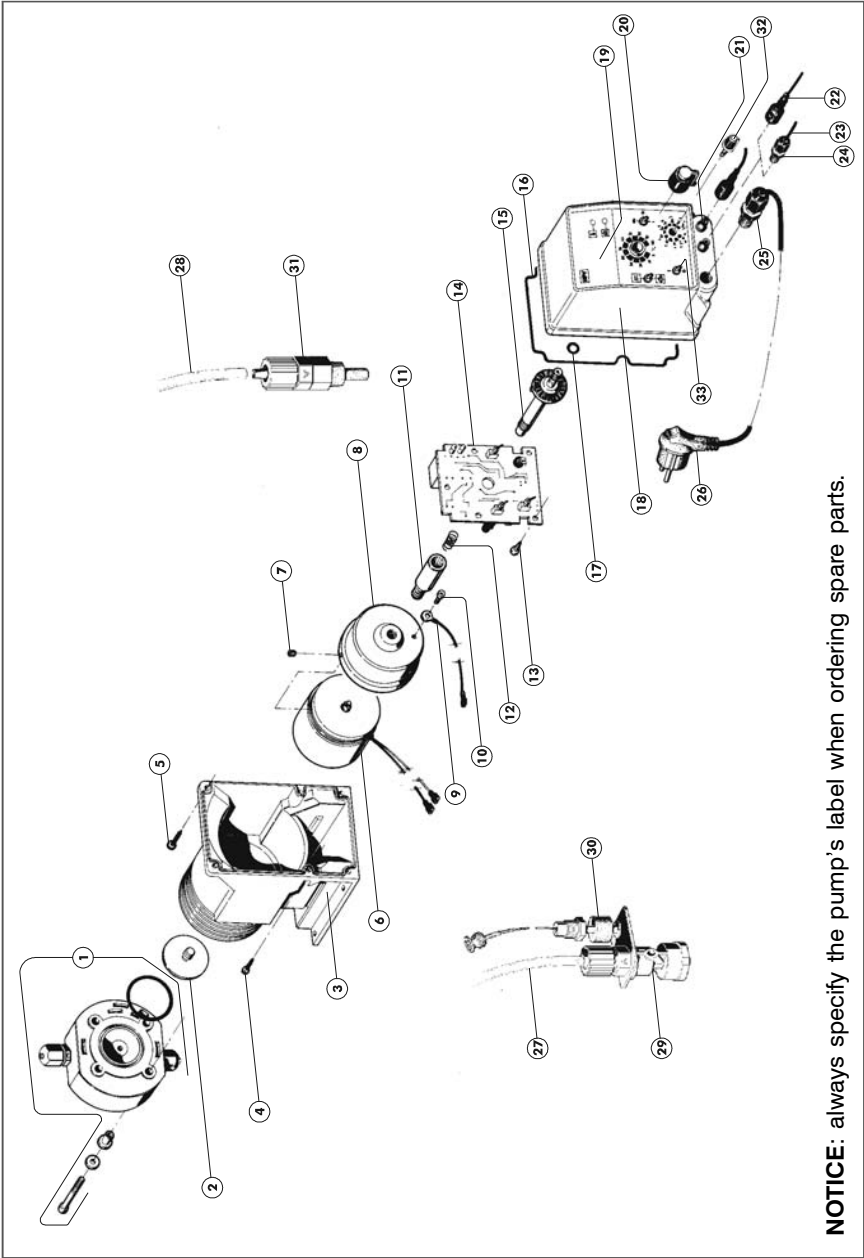

**NOTICE:** always specify the pump's label when ordering spare parts.

## "H" Series dimensions

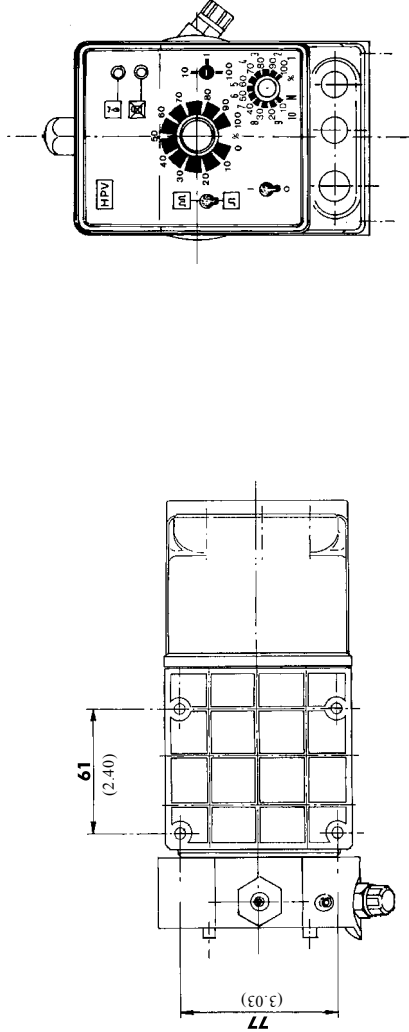
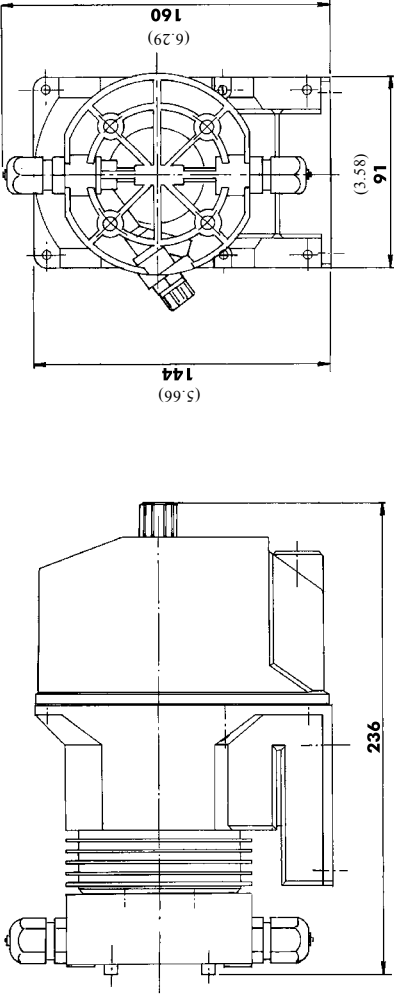

**Bold Values : mm**  
**Parenthesis values : inch**



## Self-venting pump head

This pump head removes the gas from gaseous chemicals during operation, independently of back pressure.

Attention: valves cannot be changed from their original position.

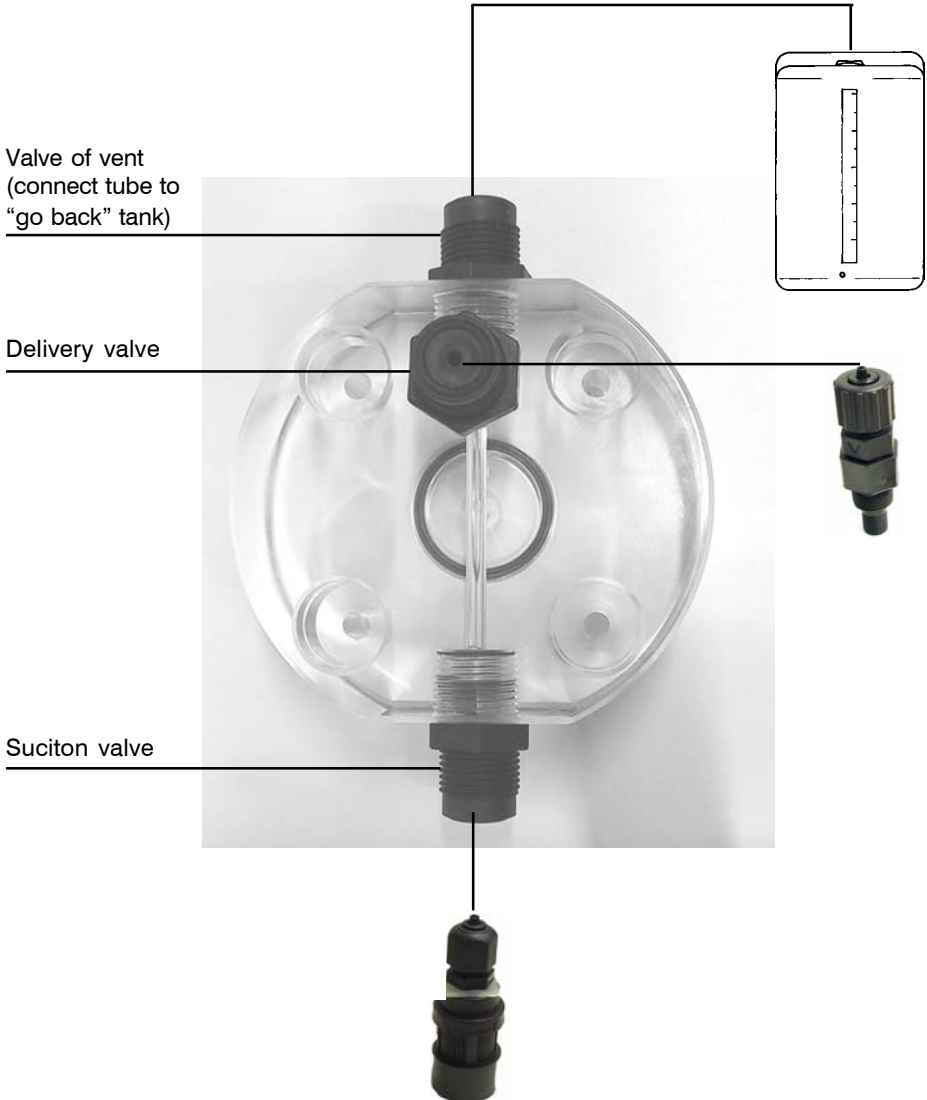





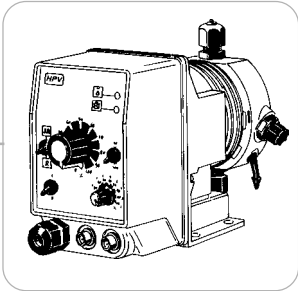

*When dismantling a pump please separate material types and send them according to local recycling disposal requirements.  
We appreciate your efforts in supporting your local Recycle Environmental Program.  
Working together we'll form an active union to assure the world's invaluable resources are conserved.*